

MD 559

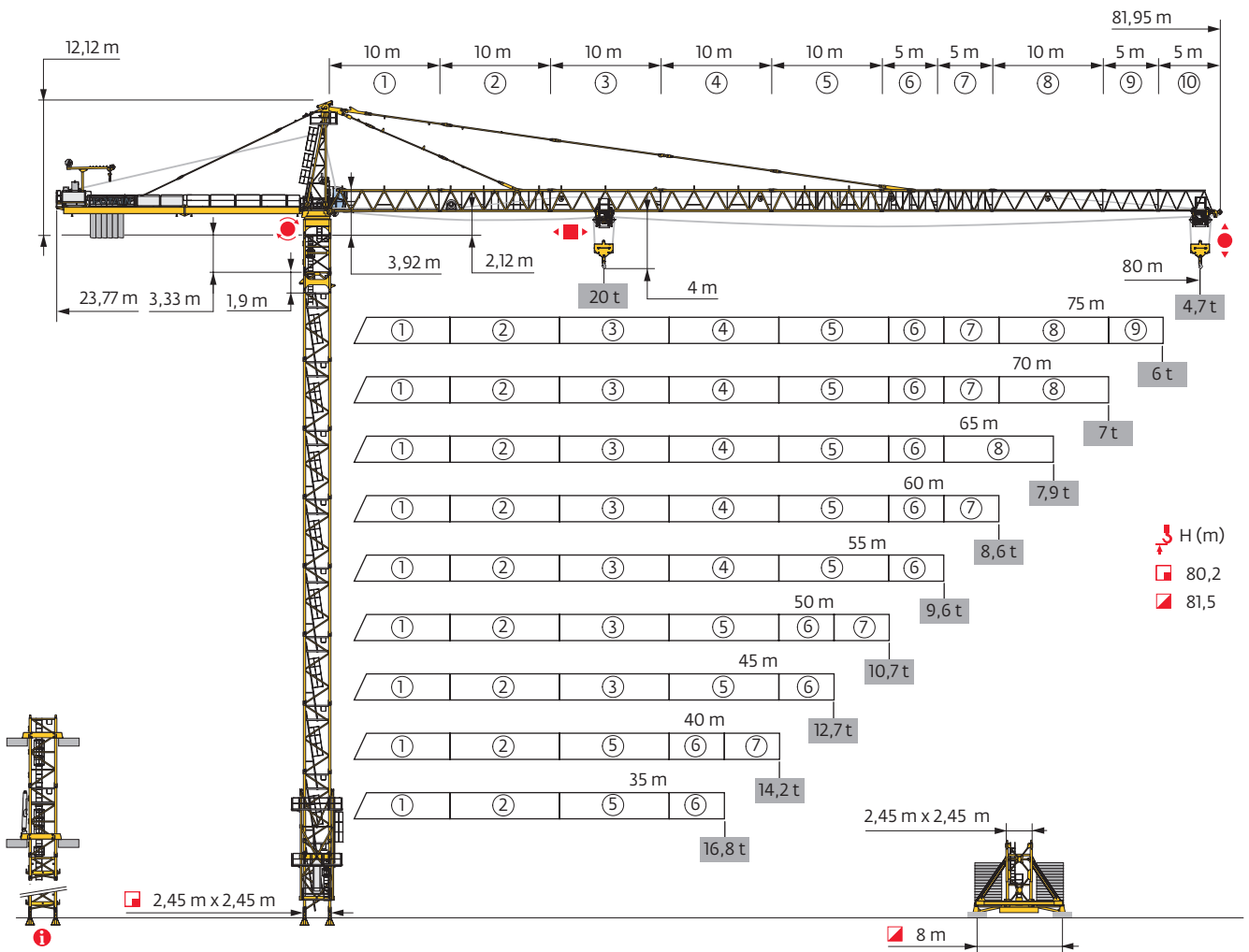

Potain Plus Power Control

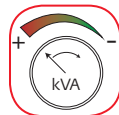

Top Site

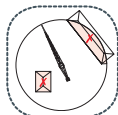

Top Tracing 3

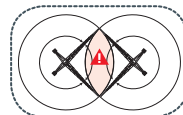

CabLIFT

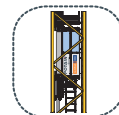

TCL



Mât - Réactions / Mast - Reaktionskräfte / Mast - Reactions / Mástil - Reacciones / Torre - Reazioni
 Tramo - Reacções / Реакция опор мачты

2,45 m - P 800B											
AVL (m)	35	40	45	50	55	60	65	70	75	80	
(m)	80,2	80,2	78,6	78,6	78,6	78,6	78,6	78,6	78,6	78,6	
/P _r (m)	78,6	78,6	78,6	78,6	78,6	78,6	78,6	78,6	78,6	78,6	
	3,33 m	1	1	1	1	1	1	1	1	1	
	1,9 m	1	1	1	1	1	1	1	1	1	
	3,33 m	2	2	0	0	0	0	0	0	0	
	5 m	14	14	15	15	15	15	15	15	15	
F2 (t)	●	266	265	256	252	257	256	260	260	265	266
	■	341	343	319	326	326	327	323	326	329	333
F3 (t)	●	184	181	172	166	167	163	176	174	177	176
	■	269	270	245	249	246	244	239	239	241	244

2,45 m - Y 800B											
AVL (m)	35	40	45	50	55	60	65	70	75	80	
(m)	81,5	81,5	81,5	81,5	79,9	79,9	81,5	81,5	81,5	81,5	
/P _r (m)	81,5	81,5	79,9	81,5	79,9	79,9	79,9	79,9	79,9	81,5	
	3,33 m	1	1	1	1	1	1	1	1	1	
	1,9 m	1	1	1	1	1	1	1	1	1	
	3,33 m	2	2	2	2	0	0	2	2	2	
	5 m	13	13	13	13	14	14	13	13	13	13
F1 (t)	●	150	147	147	147	141	139	147	145	148	152
	■	187	188	185	189	176	175	185	186	187	189

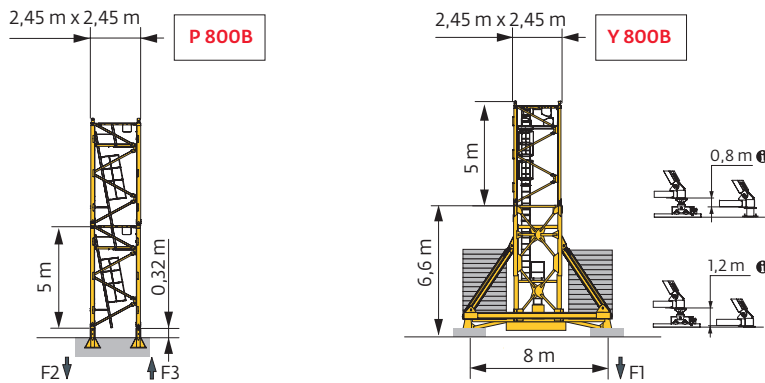

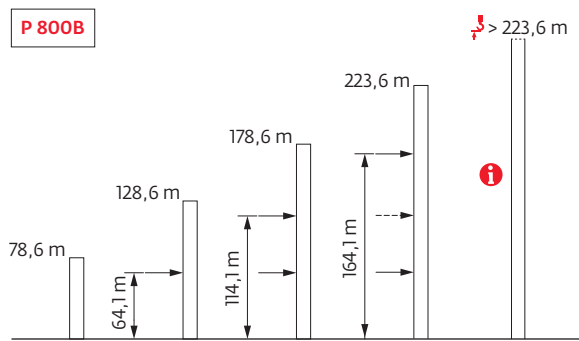

i Accès motorisés types CabLIFT et TCL : compositions de mât, de lest de base et réactions adaptées. / Motorisierter Zugang vom Typ CabLIFT und TCL : Mastzusammensetzung, Grundballast und Reaktionskräfte sind angepasst. / Motorized accesses of CabLIFT and TCL types: Adapted mast composition, base ballast and reactions. / Acceso a cabina con elevador tipo CabLIFT (interno) y tipo TCL (externo): Adaptación de composición de mástil, lastre de base y reacciones. / Accessi motorizzati di tipo CabLIFT e TCL: composizioni elementi torre, zavorre di base e reazioni aggiornate. / Acessos motorizados tipo CabLIFT e TCL: composições de coluna, lastro da base e reacções adaptadas. / Лифты CabLIFT и TCL для подъема крановщиков: адаптированная композиция мачты, базовый балласт и нагрузки.

Ancrages / Verankerungen / Anchorages / Anclajes / Ancoraggi
Ancoragem / якоря



Lest de base / Grundballast / Base ballast / Lastre de base / Zavorra di base
 Lastro da base / Базовый Балласт

 (t) /  2,45 m - Y 800B - 										
PAVIL (m)	35	40	45	50	55	60	65	70	75	80
81,5	144	132	132	132			120	108	108	120
79,9	120	120	108	120	108	96	96	96	96	96
74,9	96	84	84	84	72	72	72	84	84	84
69,9	72	72	72	72	72	72	72	84	84	84
64,9	72	72	72	72	72	72	72	84	84	84
59,9	72	72	72	72	72	72	72	72	84	84
54,9	72	72	72	72	72	72	72	72	72	84
49,9	72	72	72	72	72	72	72	72	72	72
44,9	72	72	72	72	72	72	72	72	72	72
39,9	72	72	72	72	72	72	72	72	72	72
34,9	72	72	72	72	72	72	72	72	72	72
29,9	72	72	72	72	72	72	72	72	72	72
24,9	72	72	72	72	72	72	72	72	72	72
19,9	72	72	72	72	72	72	72	72	72	72

Courbes de charges / Lastkurven / Load curves / Curvas de cargas / Curve di carico /
Curvas de carga / Кривые нагрузок



▼▲▲▲▲ (m)		22	25	27	30	32	35	37	40	42	45	47	50	52	55	57	60	62	65	67	70	72	75	77	80	m
▼▲▲▲▲	↓ 20 t	↓																								
80	2,9 → 25,5	20	20	18,7	16,5	15,3	13,7	12,8	11,6	10,9	10,1	9,6	8,8	8,4	7,9	7,5	7	6,7	6,3	6,1	5,7	5,4	5	4,8	4,4	t
	2,9 → 26,3	20	20	19,4	17,1	15,9	14,3	13,3	12,1	11,4	10,5	10	9,3	8,8	8,2	7,9	7,4	7,1	6,7	6,4	6	5,7	5,3	5,1	4,7	t P+
75	2,9 → 27,4	20	20	20	18	16,7	15,1	14,1	12,9	12,1	11,1	10,6	9,8	9,3	8,7	8,3	7,7	7,4	6,9	6,7	6,3	6	5,7	t		
	2,9 → 27,9	20	20	20	18,4	17,1	15,4	14,5	13,2	12,5	11,5	10,9	10,1	9,6	9	8,6	8,1	7,7	7,3	7	6,6	6,3	6	t P+		
70	2,9 → 28,4	20	20	20	18,8	17,4	15,7	14,7	13,4	12,7	11,7	11,1	10,3	9,8	9,1	8,7	8,2	7,9	7,4	7,1	6,7	t				
	2,9 → 28,8	20	20	20	19,1	17,8	16,1	15,1	13,8	13	12	11,4	10,6	10,1	9,5	9,1	8,5	8,2	7,7	7,4	7	t P+				
65	2,9 → 29	20	20	20	19,2	17,9	16,1	15,1	13,8	13	12	11,4	10,6	10,1	9,4	9	8,4	8,1	7,6	t						
	2,9 → 29,4	20	20	20	19,6	18,2	16,4	15,4	14,1	13,4	12,3	11,7	10,9	10,4	9,7	9,3	8,7	8,4	7,9	t P+						
60	2,9 → 28,7	20	20	20	19	17,6	15,9	14,9	13,6	12,8	11,8	11,2	10,4	9,9	9,3	8,9	8,3	t								
	2,9 → 29,1	20	20	20	19,3	18	16,2	15,2	13,9	13,2	12,2	11,5	10,7	10,2	9,6	9,2	8,6	t P+								
55	2,9 → 28,8	20	20	20	19,1	17,7	16	15	13,7	12,9	11,9	11,3	10,5	10	9,3	t										
	2,9 → 29,1	20	20	20	19,4	18	16,3	15,3	14	13,2	12,2	11,6	10,8	10,3	9,6	t P+										
50	2,9 → 28,6	20	20	20	19	17,6	15,9	14,9	13,6	12,8	11,8	11,2	10,4	t												
	2,9 → 29	20	20	20	19,2	17,9	16,2	15,2	13,9	13,1	12,1	11,5	10,7	t P+												
45	2,9 → 29,8	20	20	20	19,8	18,4	16,6	15,6	14,3	13,5	12,4	t														
	2,9 → 30,2	20	20	20	20	18,7	16,9	15,9	14,5	13,8	12,7	t P+														
40	2,9 → 29,2	20	20	20	19,4	18	16,2	15,2	13,9	t																
	2,9 → 29,5	20	20	20	19,7	18,3	16,5	15,5	14,2	t P+																
35	2,9 → 29,6	20	20	20	19,7	18,3	16,5	t																		
	2,9 → 30	20	20	20	20	18,6	16,8	t P+																		

Poids de flèche & lest de contre-flèche / Auslegergewicht & Gegenauslegerballast / Jib weight & counter-jib ballast / Peso de flecha y lastre de contra-flecha/Peso del braccio & zavorra di contro-braccio/Peso da lança & lastro da contra lança/Вес стрелы и балласт контр-стрелы

▼▲▲▲▲	▼▲▲▲▲ (kg) (+/- 5%)	▣		▲ (kg)
	↓	6000 kg	4000 kg	
80 m	26190	6	0	36000
75 m	25690	5	1	34000
70 m	24940	4	2	32000
65 m	23855	4	1	28000
60 m	23545	3	2	26000
55 m	22460	3	1	22000
50 m	20775	2	1	16000
45 m	19690	1	2	14000
40 m	17765	1	1	10000
35 m	16685	0	2	8000

CBC - 6000 kg

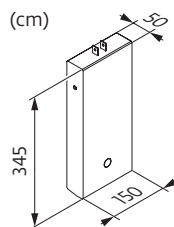

CBD - 4000 kg

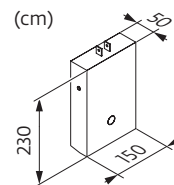



Encombremet et poids / Abmessungen und Gewicht / Dimensions and weight / Dimensiones y peso / Ingombro e peso
 dimensões e pesos / габаритные размеры и вес

Partie tournante / Drehender Kranteil / Slewing crane part / Parte giratoria
 Parte rotante / Parte rotativa / Поворотная часть : 80 м - 270/320 LVF

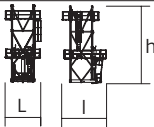
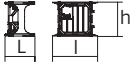
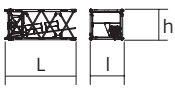
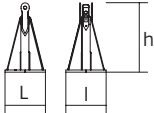
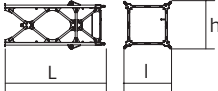
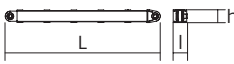
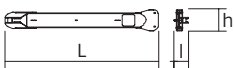

Partie tournante / Drehender Kranteil / Slewing crane part Parte giratoria / Parte rotante / Parte rotativa Поворотная часть	L (m)	l (m)	h (m)	kg (+/- 5%)		
Contre-flèche / Gegenausleger Counter-jib / Contra-flecha Controbraccio / Contra-lança Контр-стрела		11,7	4,7	1,96	6600	
		11,04	3,74	2,07	4925	
Porte-flèche / Auslegerträger Cathed / Porta-flecha Cuspide / Suporte de lança Оголовок		3,54	1,99	9,86	8265	
Cabine / Kabine Cab / Cabina Cabina / Cabina Кабина	Ultra View	5	2,5	2,77	1875	
Pivot / Krankopf Towerhead / Pivote Portaralla / Pivot Секция поворотной части	2,45 m	3,7	2,9	3,87	11190	
Treuil de levage (+ câble) / Hubwerk (+ Seil) Hoisting winch (+ rope) / Mecanismo de elevación (+ cabo) Argano di sollevamento (+ fune) Guincho de elevação (+ cabo) Подъемная лебедка (+ канатом)	270/320 LVF	5,09	2,3	2,24	9885	
Châssis intermédiaire de treuil / Zwischenrahmen des Triebwerks Intermediate winch frame / Chassis intermedio del mecanismo Chassis intermedio / Chassis intermédio do guincho средняя часть рамы лебедки		3,26	2,89	1,66	5663	
Elément de flèche / Auslegerement Jib section / Elemento de flecha Elemento di braccio / Elemento de lança Секция стрелы		①	10,36	1,9	2,54	5100
		② 15 DVF	10,33	1,9	2,34	5190
		③	10,23	1,9	2,4	3010
		④	10,23	1,9	2,33	2770
		⑤	10,23	1,9	2,32	2835
Elément de flèche / Auslegerement Jib section / Elemento de flecha Elemento di braccio / Elemento de lança Секция стрелы		⑥	5,32	1,9	2,25	1725
		⑦	5,24	1,9	2,04	1080
		⑨	5,18	1,9	1,97	550
		⑩	5,08	1,9	1,97	500
Chariot / Laufkatze Trolley / Carrello Carro / Carro-distribuidor Тележка		1,95	2,23	1,67	785	
Moufle / Hubflasche Pulley block / Aparelo Bozzello / Cadernal Полиспаст		1,68	0,28	2,45	570	

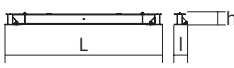
Рулбне / Kranturm / Crane tower Mástil / Torre / Torre Башня крана		L (m)	l (m)	h (m)	kg (+/- 5%)	
Cage de télescopage / Teleskopwagen Telescopic cage / Jaula de telescopaje Gabbia di telescopaggio / Gaiola de telescopagem для телескопирования крана		2,45 m	4,62	5,79	10,23	13245
K 849/K 849 Mât de télescopage / Teleskopiermast Telescoping mast / Tramo de telescopaje Elemento di telescopaggio / Tramo de Telescopagem Мачта для телескопирования		2,45 m	2,14	3,25	2,5	2985
KR 849A KRMT 849A KR 849C KRMT 849C		2,45 m	5,23 5,23 3,57 3,57	2,53 2,55 2,53 2,55	2,5 2,53 2,53 2,53	4290 4090 3195 3205
Pieds de scellement / VerankerungsfüÙe Fixing angles / Pie de empotramiento Montante da annegare / Angulos fixadores анкера		P 800B	0,75	0,75	1,28	465
Mât-châssis / Grundmasteinheit Basic mast unit / Tramo-chasis Elemento base / Tramo-chassis Мачта для крепления к шасси		Y 800B	6,03	2,93	2,93	8620
Haubans / Mastabstützungen Struts / Tornapuntas Puntoni / Escoras Растяжка		Y 800B	5,51	0,5	0,45	1110
1/2 Longeron / 1/2 Längsträger 1/2 Side member / 1/2 Larguero 1/2 Longherone / 1/2 Longarina 1/2 боковина		Y 800B	5,68	1,24	0,73	1520
Longeron / Längsträger Side member / Larguero Longherone / Longarina боковина		Y 800B	12	1,24	0,73	3050
Support lest / Ballastträger Ballast support / Soporte de lastre Supporto zavorra / Suporte de lastro Опора балласта		Y 800B	3,75	0,37	0,92	1085
Traverse de châssis / Unterwagentraverse Chassis beam / Traviesa chasis Traversa carro / Travessa chassis балка шасси		Y 800B	8,7	0,83	0,74	2240

Mécanismes / Triebwerke / Mechanisms / Mecanismos / Meccanismi
 Mecanismos / Механизмы

400 V - 50 Hz 480 V - 60 Hz								ch - PS hp	kW		
	400 V - 50 Hz	270 LVF 100 Optima	m/min t	51 20	66,5 15	96 10	139 5	162 3,5	270	200	532 m
	480 V - 60 Hz	320 LVF 100 Optima	m/min t	60 20	78 15	112 10	154 6,8	162 5,8	320	240	
	400 V - 50 Hz 480 V - 60 Hz	15 DVF 16 Optima	m/min	0 → 50 (20 t) 0 → 67 (10 t) 0 → 100 (2,5 t)					15	11	
		RVF 173 Optima+	tr/min U/min rpm	0 → 0,7					3 x 10	3 x 7,5	

IEC 60204-32		
400 V (+10% -10%) 50 Hz	257 → 149 kVA	
480 V (+6% -10%) 60 Hz	297 → 169 kVA	

	FR	DE	EN	ES	IT	PT	RU
	Équipements standards	Standardausrüstungen	Standard equipment	Equipamiento de serie	Equipaggiamento standard	Equipamento de série	Стандартное оборудование
	Équipements optionnels	Sonderausrüstungen	Options	Equipamiento opcional	Equipaggiamento in opzione	Equipamento opcional	Дополнительное оборудование (опция)
	Fonction Potain Plus : Courbes de charges Plus	Funktion Potain Plus: Plus-Lastkurven	Potain Plus function: Plus load curves	Función Potain Plus: Diagrama de cargas Plus	Funzione Potain Plus: Curve di carico Plus	Função Potain Plus: Diagrama de cargas Plus	Функция контроля мощности Potain Plus: Диаграммы грузоподъемности Plus
	Hauteurs sous crochet associées aux courbes de charges Plus	Hakenhöhen mit Plus-Lastkurven	Hook heights with Plus load curves	Altura bajo gancho, usando el diagrama de cargas Plus	Altezze sotto gancio con curve di carico Plus	Altura livre, utilizando o diagrama de cargas Plus	Высота под крюком для диаграмм грузоподъемности Plus
	Réactions en service	Reaktionskräfte in Betrieb	Reactions in service	Reacciones en servicio	Reazioni in servizio	Reacções em serviço	Реакция при работе
	Réactions hors service	Reaktionskräfte außer Betrieb	Reactions out of service	Reacciones fuera de servicio	Reazioni fuori servizio	Reacções fora de serviço	Реакция в покое
	Poids total du lest	Ballast-Gesamtgewicht	Total ballast weight	Peso total del lastre	Peso totale della zavorra	Peso total do lastro	Общий вес балласта
	Cadre d'ancrage serré	Fester Verankerungsrahmen	Tightened anchorage frame	Marco de anclaje de apriete	Quadro di ancoraggio stretto	Quadro de amarração apertado	Прикрепленная анкерная рама
	Cadre d'ancrage desserré	Looser Verankerungsrahmen	Loosened anchorage frame	Marco de anclaje de desapriete	Quadro di ancoraggio allentato	Quadro de amarração solto	Отсоединенная анкерная рама
	Poids de flèche	Auslegergewicht	Jib weight	Peso de flecha	Peso del braccio	Peso da lança	вес стрелы
	Camion 13,4 m	Lkw 13,4 m	Lorry 13,4 m	Camión 13,4 m	Camion 13,4 m	Camião 13,4 m	Rрузовой автомобиль 13,4 м
	Conteneur High Cube 40', et/ou Flat Rack 20'	Container High Cube 40', und/oder Flat Rack 20'	Container High Cube 40', and/or Flat Rack 20'	Contenedor High Cube 40', y/o Flat Rack 20'	Container High Cube 40', e/o Flat Rack 20'	Contentor High Cube 40', e/ou Flat Rack 20'	40-футовый контейнер повышенной вместимости High Cube, и/или 20-футовая открытая платформа Flat Rack
	Levage	Heben	Hoisting	Elevación	Sollevamento	Elevação	Подъем
	Distribution	Katzfahren	Trolleying	Distribución	Distribuzione	Distribuição	Перемещение по стреле
	Orientation	Schwenken	Slewing	Orientación	Rotazione	Rotação	Поворот
	Translation	Kranfahren	Travelling	Traslación	Traslazione	Translação	Перемещение крана
	Puissance requise	Erforderliche Leistung	Required power	Potencia Necesaria	Potenza richiesta	Potência Necessária	Потребляемая мощность
	Fonction Power Control : vitesses treuils adaptées à la puissance disponible	Funktion Power Control: Geschwindigkeiten der Triebwerke werden an die verfügbare Leistung angepasst	Power Control Function: winch speeds adapted to the available power	Función Power Control: marchas de los cabrestantes adaptadas a la potencia disponible	Funzione Power Control: velocità degli argani adattate alla potenza disponibile	Função Power Control: velocidades de guincho adaptadas à potência disponível	Функция контроля мощности Power Control: регулировка скорости лебедок в зависимости от доступной мощности
	Nous consulter	Auf Anfrage	Consult us	Consultarnos	Consultateci	Consultar-nos	Проконсультируйтесь у нас
	Document commercial non contractuel. Pour toute information technique se référer à la notice correspondante.	Unverbindliches Vertriebsdokument. Für technische Informationen, siehe die entsprechenden Anweisungen.	This commercial document is not legally binding. For any technical information, please refer to the corresponding instructions.	Documento comercial no contractual. Para cualquier información técnica, ver la noticia correspondiente.	Documento commerciale non vincolante, per tutte le informazioni tecniche fare riferimento al catalogo istruzioni.	Documento comercial não contratual. Para qualquer informação técnica complementar consultar as respectivas instruções.	Этот коммерческий документ не является юридически обязательным. Для получения технической информации, см. соответствующие инструкции.

