

MD 1600

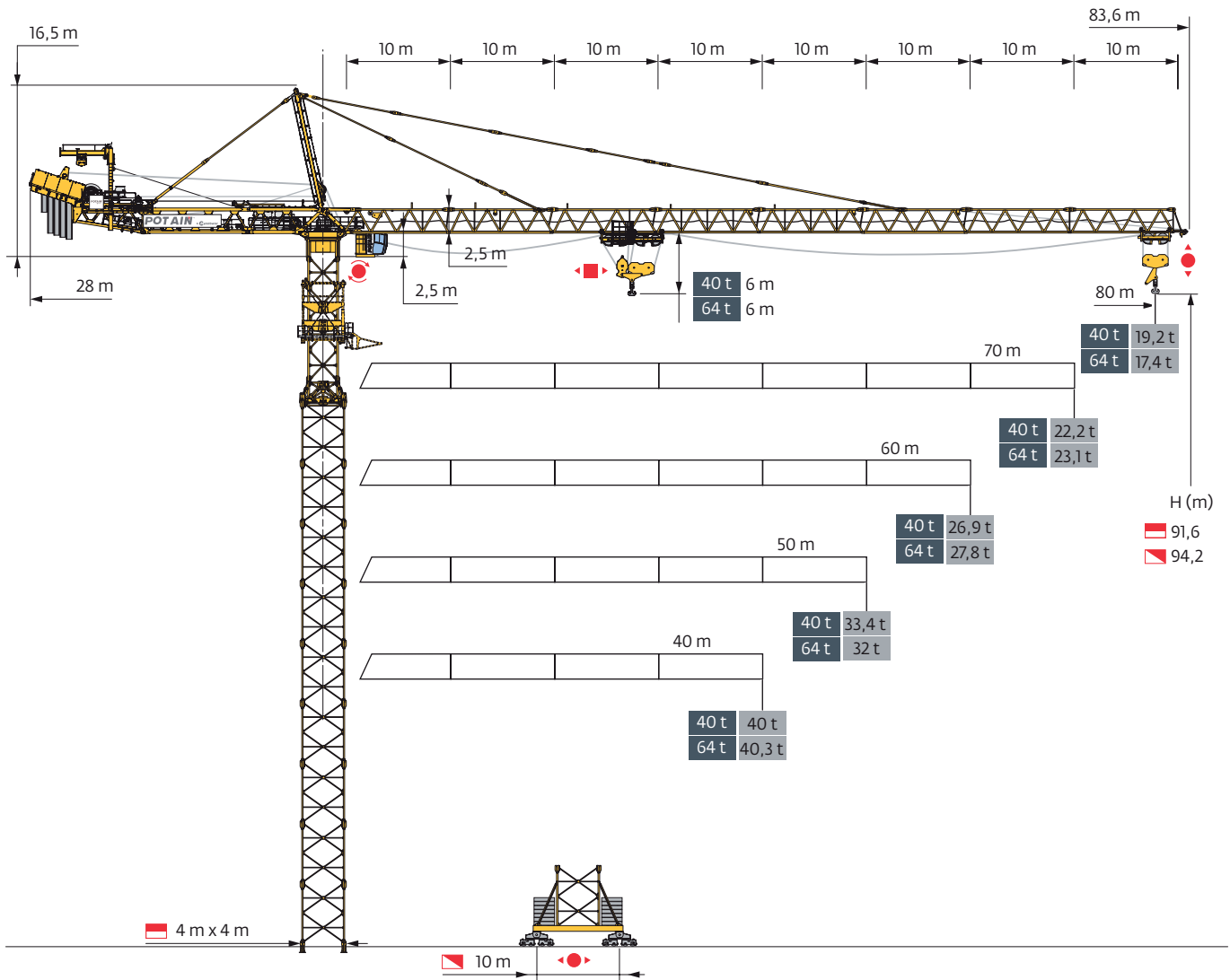

Mât - Réactions / Mast - Reaktionskräfte / Mast - Reactions / Mástil - Reacciones / Torre - Reazioni
 Tramo - Reações / Реакция опор мачты

4 m

40 m → 80 m

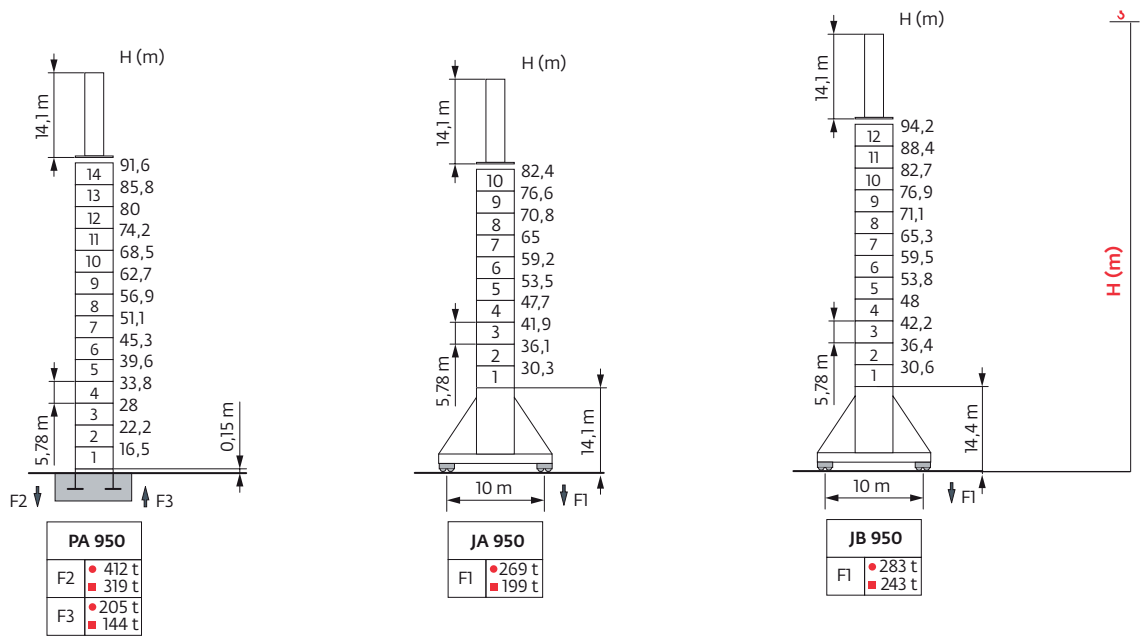

Pour toute demande spécifique merci de nous consulter. / Für jede spezielle Anfrage, bitte bei uns rückfragen.

For any special request, please consult us. / Para toda pregunta específica, gracias por consultarnos.

Per qualsiasi domanda specifica, vi preghiamo di contattarci. / Queiram por favor contactar-nos para qualquer esclarecimento técnico adicional.

В случае нестандартных вопросов, пожалуйста, консультируйтесь с нами.

Autres implantations / Aufstellmöglichkeiten / Mounting possibilities / Otras implantaciones / Altre postazioni
 Outras implantações / Возможности установки ⓘ

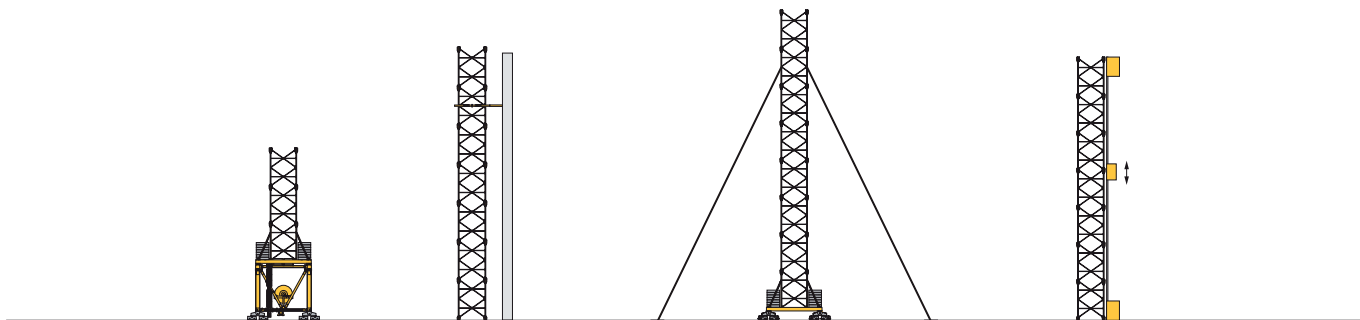

Courbes de charges / Lastkurven / Load curves / Curvas de carga / Curve di carico
 Curvas de carga / Кривые нагрузок



80 m	6,5	▶	39,2	45	50	55	60	65	69,2	77,3	80	m
▲▲▲▲			40	34	30	26,7	24	21,7	20	20	19,2	t
40 m/50 m/60 m/70 m	6,5	▶	40	45	50	55	60	65	70			m
▲▲▲▲			40	37,8	33,4	29,8	26,8	24,3	22,1			t

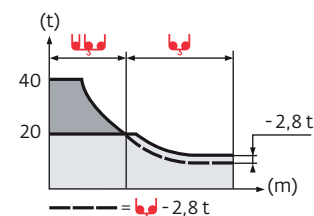

80 m	5,7	▶	39,2	40	45	50	55	60	65	69,4	71,1	75	80	m
▲▲▲▲			40	39	34	30	26,8	24,1	21,8	20	20	18,7	17,2	t
40 m/50 m/60 m/70 m	5,7	▶	40	45	50	55	60	65	70					m
▲▲▲▲			40	37,8	33,4	29,9	26,9	24,4	22,2					t

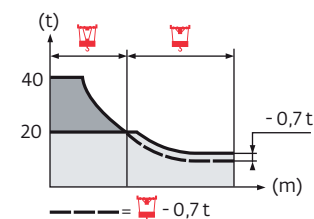

80 m	6,5	▶	24,6	25	30	35	40	43,3	48,7	50	55	60	65	70	75	80	m
▲▲▲▲			64	62,7	50,6	42	35,5	32	32	31	27,7	25	22,6	20,6	18,9	17,4	t
40 m/50 m/60 m/70 m	6,5	▶	26,9	30	35	40	45	47,4	50	53,3	55	60	65	70			m
▲▲▲▲			64	56,3	46,9	39,8	34,3	32	32	32	30,8	27,8	25,3	23,1			t

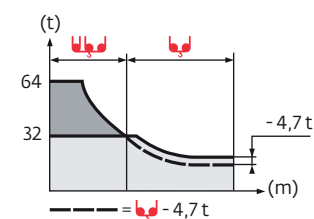

80 m	5,7	▶	24,7	25	30	35	40	43,8	45,1	50	55	60	65	70	75	80	m
▲▲▲▲			64	63,2	51,1	42,4	36	32	32	28,1	24,8	22,1	19,7	17,7	16	14,5	t
40 m/50 m/60 m/70 m	5,7	▶	27,1	30	35	40	45	48	49,4	50	55	60	65	70			m
▲▲▲▲			64	56,8	47,4	40,3	34,8	32	32	31,5	27,9	24,9	22,4	20,2			t

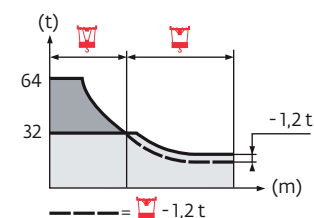

Mécanismes / Triebwerke / Mechanisms / Mecanismos / Meccanismi
 Mecanismos / Механизмы

400 V - 50 Hz 480 V - 60 Hz														ch - PS hp	kW		
	400 V - 50 Hz	270 LVF 100 Optima	40 t	m/min	50	65	93	131	162	25	33	47	66	81	270	200	532 m
	t			20	15	10	6,7	3,7	40	30	20	14	8,2				
	480 V - 60 Hz	320 LVF 100 Optima	m/min	60	78	112	154	162	30	39	56	77	81	320	240		
	t			20	15	10	6,8	5,8	40	30	20	14,2	12,2				
400 V - 50 Hz	270 LVF 160 Optima	64 t	m/min	31	41	58	93	107	16	20	29	47	54	270	200	641 m	
t			32	24	16	8	4,9	64	48	32	16	11,6					
480 V - 60 Hz	320 LVF 160 Optima	m/min	37	49	70	110	107	19	24	35	55	54	320	240			
t			32	24	16	8	8,5	64	48	32	16	17,5					
	400 V - 50 Hz 480 V - 60 Hz	15 DVF 16	40 t	m/min	0 → 33 (40 t) 0 → 50 (20 t) 0 → 67 (10 t) 0 → 100 (2,5 t)										15	11	
		25 DVF 30	64 t	m/min	0 → 25 (64 t) 0 → 50 (32 t) 0 → 90 (16 t) 0 → 115 (8 t)										25	18,5	
	400 V - 50 Hz 480 V - 60 Hz	RVF 194 Optima+		tr/min U/min rpm	0 → 0,6										4 x 15	4 x 11	

IEC 60204-32	kVA
400 V (+10% -10%) 50 Hz	270 LVF / 15 DVF: 263 → 155 kVA 270 LVF / 25 DVF: 271 → 163 kVA
480 V (+6% -10%) 60 Hz	320 LVF / 15 DVF: 303 → 175 kVA 320 LVF / 25 DVF: 311 → 183 kVA

FR	DE	EN	ES	IT	PT	RU
Équipements standards	Standardausrüstungen	Standard equipment	Equipamiento de serie	Equipaggiamento standard	Equipamento de série	Стандартное оборудование
Équipements optionnels	Sonderausrüstungen	Options	Equipamiento opcional	Equipaggiamento in opzione	Equipamento opcional	Дополнительное оборудование (опция)
Réactions en service	Reaktionskräfte in Betrieb	Reactions in service	Reacciones en servicio	Reazioni in servizio	Reacções em serviço	Реакция при работе
Réactions hors service	Reaktionskräfte außer Betrieb	Reactions out of service	Reacciones fuera de servicio	Reazioni fuori servizio	Reacções fora de serviço	Реакция в покое
Levage	Heben	Hoisting	Elevación	Sollevarmento	Elevação	Подъем
Distribution	Katzfahren	Trolleying	Distribución	Distribuzione	Distribuição	Перемещение по стреле
Orientation	Schwenken	Slewing	Orientación	Rotazione	Rotação	Поворот
Translation	Kranfahren	Travelling	Traslación	Traslazione	Translação	Перемещение крана
Puissance requise	Erforderliche Leistung	Required power	Potencia Necesaria	Potenza richiesta	Potência Necessária	Потребляемая мощность
Fonction Power Control : vitesses treuils adaptées à la puissance disponible	Funktion Power Control: Geschwindigkeiten der Triebwerke werden an die verfügbare Leistung angepasst	Power Control Function: winch speeds adapted to the available power	Función Power Control: marchas de los cabrestantes adaptadas a la potencia disponible	Funzione Power Control: velocità degli argani adattate alla potenza disponibile	Função Power Control: velocidades de guincho adaptadas à potência disponível	Функция контроля мощности Power Control: регулировка скорости лебедок в зависимости от доступной мощности
Nous consulter	Auf Anfrage	Consult us	Consultarnos	Consultateci	Consultar-nos	Проконсультируйтесь у нас
Document commercial non contractuel. Pour toute information technique se référer à la notice correspondante.	Unverbindliches Vertriebsdokument. Für technische Informationen, siehe die entsprechenden Anweisungen.	This commercial document is not legally binding. For any technical information, please refer to the corresponding instructions.	Documento comercial no contractual. Para cualquier información técnica, ver la noticia correspondiente.	Documento commerciale non vincolante, per tutte le informazioni tecniche fare riferimento al catalogo istruzioni.	Documento comercial não contractual. Para qualquer informação técnica complementar consultar as respectivas instruções.	Этот коммерческий документ не является юридически обязательным. Для получения технической информации, см. соответствующие инструкции.

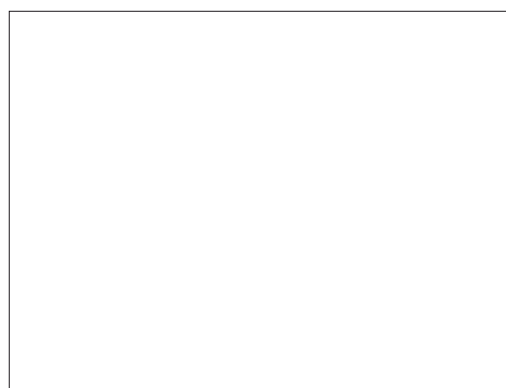

Grove Manitowoc National Crane Potain

Americas
Manitowoc, Wisconsin, USA
 Tel: +1 920 684 6621
 Fax: +1 920 683 6277

Shady Grove, Pennsylvania, USA
 Tel: +1 717 597 8121
 Fax: +1 717 597 4062

Europe, Middle East, Africa
Dardilly, France
 Tel: +33 (0)4 72 18 20 20
 Fax: +33 (0)4 72 18 20 00

China
Shanghai, China
 Tel: +86 21 6457 0066
 Fax: +86 21 6457 4955

Greater Asia-Pacific
Singapore
 Tel: +65 6264 1188
 Fax: +65 6862 4040